

GENERAL SPECIFICATIONS

FRAME SIZE : 180x180x110mm.
HOUSING : ALUMINIUM ALLOY
IMPELLER : PBT THERMOPLASTIC UL94V-0
BEARING TYPE : BALL BEARING
OPERATION TEMPERATURE : -10°C - +65°C
RELATIVE HUMIDITY : 35% ~ 85%
MOTOR : CAPACITOR-RUN INDUCTION MOTOR

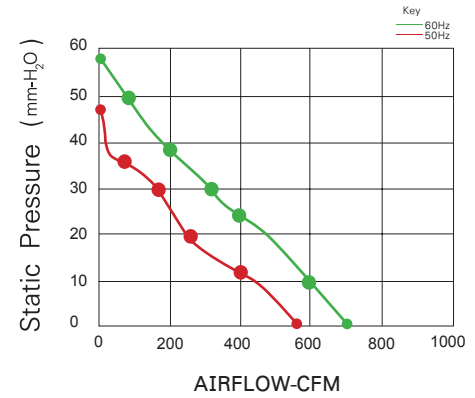

WB1811H5PC...

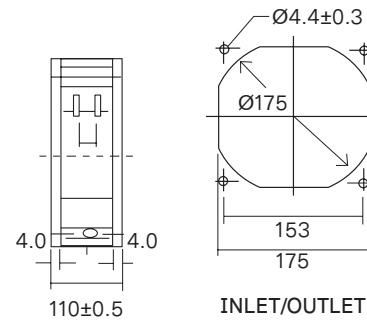
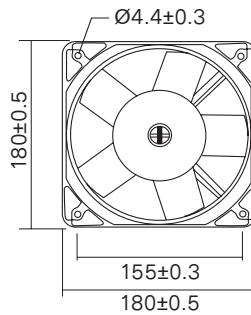
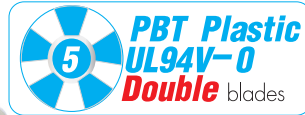

MODEL	VOLTAGE (V)	FREQ (HZ)	CURRENT (A)	POWER (W)	SPEED (RPM)	NOISE (DBA)	AIRFLOW (CFM)
WB1811H5PC-A1LG	100-125vac	50/60	0.82	80	2600/3000	69/73	565/670
WB1811H5PC-A2LG	200-240vac	50/60	0.40	80	2600/3000	69/73	565/670

อุปกรณ์เสริม



ตะแกรง G-180

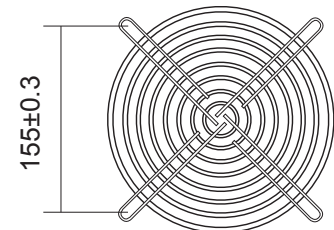
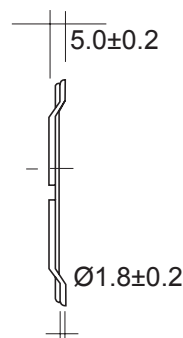

* หน่วย : mm. *



ฟิลเตอร์กันน้ำ WFU-9805P2

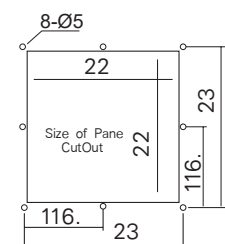
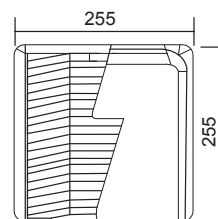
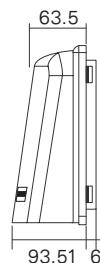

* หน่วย : mm. *

* ราคาสินค้าไม่รวมภาษีมูลค่าเพิ่มและเปลี่ยนแปลงได้โดยไม่ต้องแจ้งให้ทราบล่วงหน้า *