



SD-96 Series
Moving Coil Type



SD-96KW

Specifications

- Reference standard : EN/IEC 60051
- Case-dimensions : DIN 43700
- Scales and pointer : DIN 43802
- Magnetic influence : DIN 43780
- Safety : IEC 1010-1
- Housing : Self-extinguishing polymer ABS according to UL94V-0
- Protection for housing : IP40 as standard
- Protection for terminals : IP20 with back cover
- Accuracy class : 1.5
- Operating frequency : 45~65Hz
- Dielectric test voltage : 2KV/ 50Hz/ 1minute
- Overload AC voltage : x1.2 continuous(x2 for 5 seconds)
- AC Current : x1.2 continuous(x10 for 5 seconds)
- Power consumption**
- Voltage : $\leq 1.8VA$ for 500V
- Current : $\leq 0.7VA$ for 5A
- Active power factor : $\cos\phi -0.5 \cos...1...0.5$ ind
- Reference temperature : $23^{\circ}C \pm 2^{\circ}C$
- Operating temperature : $-25^{\circ}C$ to $40^{\circ}C$
- Storage temperature : $-40^{\circ}C$ to $70^{\circ}C$
- Relative humidity : $\leq 85\%$

กิโลวัตต์มิเตอร์ (Active Power Meter) Moving Coil Type

รุ่น (Model)	Measuring Range	Connection through current transformers	Connection Input Voltage	Accuracy Class
SD-96KW	0-15KW	20/5A (3)	380V	1.5

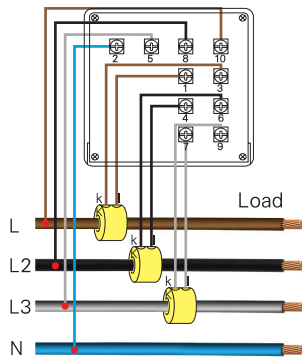

CONNECTION DIAGRAMS

ACTIVE POWER METER

3P 4W UNBALANCED LOAD

CONNECTION THROUGH CURRENT TRANSFORMERS

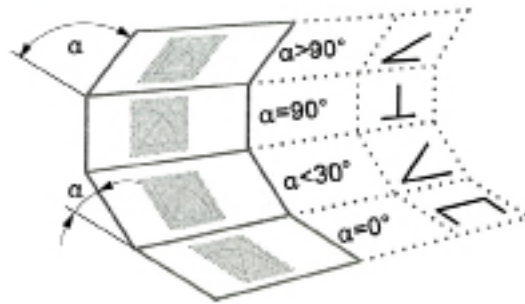

Markings concerning the working position

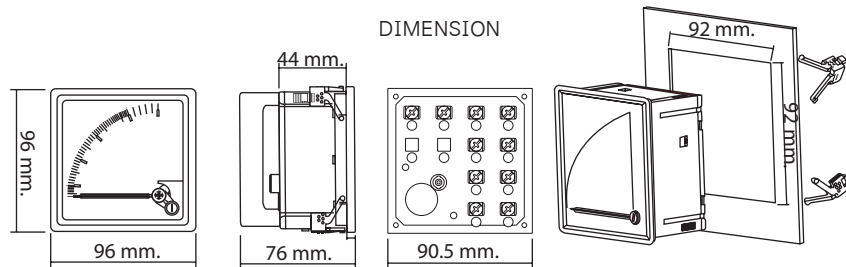

DIMENSION

